

# BRASS CR STOP COCK FEMALE THREAD END

COMPLY WITH SS75-2:1978  
AS/NZS4020:2005  
SS375:2015  
BSEN12165:2016

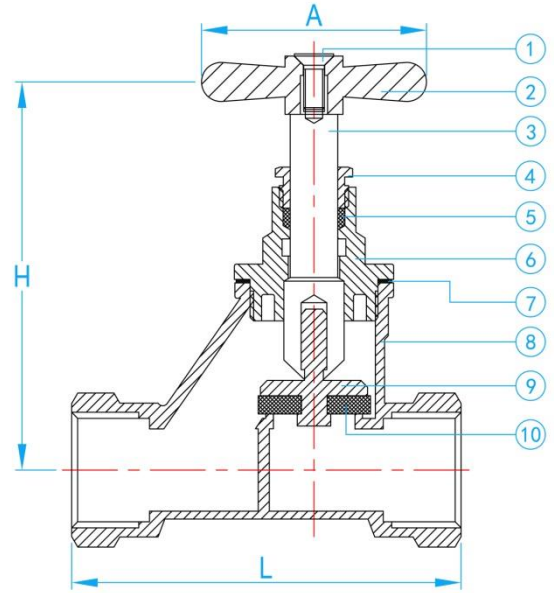
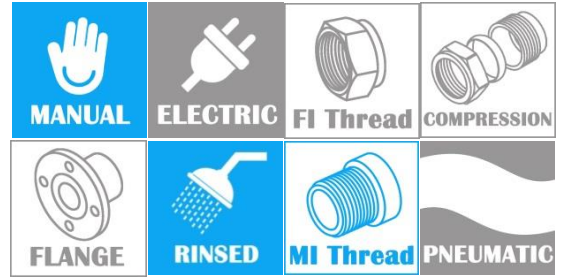

CROSS SECTIONAL VIEW

### STANDARD SPECIFICATIONS

Working Pressure	200 Psi
Applicable Medium	Water

### DIMENSIONS

SKU	Size (mm)	A (mm)	H (mm)	L (mm)	WEIGHT (kg)	PCS/CTN
SCFFCRN015	15	52	79	70	0.278	80
SCFFCRN020	20	52	90	90	0.476	25
SCFFCRN025	25	63	110	106	0.986	20

### COMPONENT PARTS

ITEM	PARTS	MATERIAL
1	Screw	Brass Or AISI304
2	Handle	DZR Brass
3	Spindle	DZR Brass
4	Gland Nut	DZR Brass
5	Gland Packing	Teflon
6	Head	DZR Brass
7	Gasket	PTFE
8	Body	DZR Brass
9	Washer Plate	DZR Brass
10	Washer	EPDM