

COPPER PRESS FIT FITTINGS (M PROFILE)

COMPLY WITH BSEN1254-2: 1998

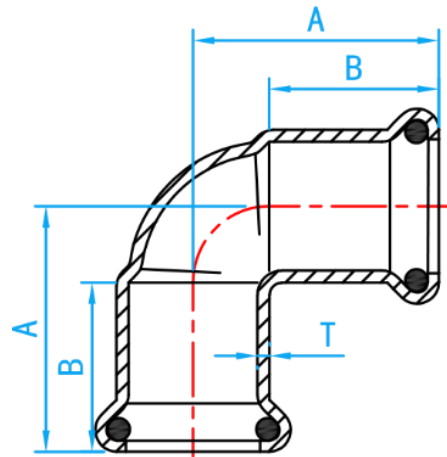

90° ELBOW



CROSS SECTIONAL VIEW

DIMENSIONS

SKU	SIZE (mm)	A (mm)	B (mm)	T (mm)	WEIGHT (Kg)	PCS/CTN
PFNE90015	15	29.0	20.0	1.5	0.045	300
PFNE90020	22	34.0	21.0	1.5	0.075	150
PFNE90025	28	40.0	23.0	1.5	0.111	90
PFNE90035	35	68.0	26.0	1.5	0.170	40
PFNE90042	42	80.0	30.0	1.5	0.247	16
PFNE90050	54	105.0	45.0	1.5	0.381	12
PFNE90065	67	132.0	50.0	2.0	0.800	6
PFNE90080	76	142.0	50.0	2.0	1.150	4